

SINCE 1889



Forced Convection Constant Temperature Oven

Model DKM300/400/600

Fourth edition

- Thank you very much for purchasing this Yamato DKM series forced convection constant temperature oven.
 - Please read the “Operating Instructions” and “Warranty” before operating this unit to assure proper operation. After reading these documents, be sure to store them securely together with the “Warranty” at a handy place for future reference.
- ⚠ Warning** : Before operating the unit, be sure to read carefully and fully understand important warnings in the operating instructions.

Yamato Scientific Co., Ltd.

Table of Contents

1. Safety precautions	1
Explanation of pictograms	1
List of symbols	2
Warning · Cautions	3
2. Before operating the unit	4
Precautions when installing the unit	4
Installation procedures · precautions	7
3. Names and functions of parts	10
Main body.....	10
Operation panel.....	11
Explanation of characters.....	12
4. Operating procedures	13
List of operation modes and functions.....	13
Operation mode · function setting keys and characters	15
Operating procedures (settings for overheat prevention device).....	16
Operating procedures (fixed temperature operation)	17
Operating procedures (quick auto stop operation)	18
Operating procedures (auto stop operation).....	20
Operating procedures (auto start operation)	22
Useful functions (calibration offset function).....	24
Useful function (setting lock function).....	25
Useful function (power outage compensation function).....	26
5. Cautions on handling	27
6. Maintenance procedures	30
Daily inspection/maintenance.....	30
7. When the unit is not to be used for a long time or when disposing	31
When the unit is not to be used for a long time or when disposing	31
Notes about disposition	31
8. Troubleshooting	32
Safety device and error codes.....	32
When a malfunction is suspected.....	33
9. After sales service and warranty	34
When requesting a repair	34
10. Specifications	35
11. Wiring diagram	36
12. List of replacement parts	37
13. List of dangerous materials	38
14. Standard installation manual	39

1. Safety precautions

Explanation of pictograms

About pictograms

A variety of pictograms are indicated in this operating instruction and on products to assure safe operation. Possible results from improper operation ignoring them are classified as follows.

Be sure to fully understand the descriptions below before proceeding to the text.



Indicates a situation which may result in death or serious injury (Note 1)



Indicates a situation which may result in minor injury (Note 2) and property damage (Note 3).

- (Note 1) Serious injury means a wound, an electrical shock, a bone fracture or intoxication that may leave after effects or require hospitalization or outpatient visits for a long time.
- (Note 2) Minor injury means a wound or an electrical shock that does not require hospitalization or outpatient visits for a long time.
- (Note 3) Property damage means damage to facilities, devices and buildings or other properties.

Meanings of pictograms



This pictogram indicates a matter that encourages the user to adhere to warning ("caution" included).
Specific description of warning is indicated near this pictogram.



This pictogram indicates prohibitions
Specific prohibition is indicated near this pictogram.



This pictogram indicates matters that the user must perform.
Specific instruction is indicated near this pictogram.

1. Safety precautions

List of symbols

Warning



General warnings



Danger!: High voltage



Danger!: High temperature



Danger!: Moving part

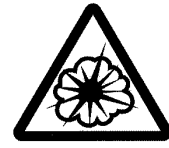

Danger!: Hazard of explosion

Caution



General cautions



Electrical shock!



Burning!



Caution for no liquid heating!



Caution for water leak!



For water only



Poisonous material

Prohibitions



General bans



Fire ban



Do not disassemble



Do not touch

Compulsions



General compulsions



Connect ground wire



Install levelly



Pull out the power plug



Regular inspection

1. Safety precautions

Warning · Cautions

Warning



Never operate the unit in an atmosphere containing flammable or explosive gas

Never operate the unit in an atmosphere containing flammable or explosive gas. Otherwise, an explosion or a fire may result since the unit is not explosion-proof. See section "13. List of dangerous materials" on page 38.



Be sure to connect the ground wire.

Be sure to connect the ground wire correctly. Otherwise, electrical leak may result and cause an electrical shock or a fire.



Ban on operation when an abnormality occurs

When a smoke or a unusual odor is seen or sensed, immediately turn the ground fault interrupter on the main unit off and pull out the power plug. A fire or an electrical shock may result.



Never use electrical power cords bundled.

When these are used bundled, they might overheat causing a fire.



Take care not to damage electrical power cords.

Avoid tightly bend, pull with a strong force or twist to prevent electrical power cords from damaging. A fire or an electrical shock may result.



Never use an explosive or a flammable material with this unit.

Never use an explosive material, a flammable material or a material containing them. An explosion or an electrical shock may result. See section "13. List of dangerous materials" on page 3.



Never try to touch a hot part.

Some parts of the unit are hot during and immediately after operation. Take special care for possible burning.



Never try to disassemble or alter the unit.

Never try to disassemble or alter the unit. A malfunction, a fire or an electrical shock may result.



Caution



When a thunder is heard.

When a thunder is heard, turn the main power off immediately. A malfunction, fire or an electrical shock may result.

2. Before operating the unit

Precautions when installing the unit

1. Carefully select an installation site.



Take special care not to install the unit at a place described below:

- Uneven surfaces or dirty surfaces
- Where flammable gas or corrosive gas exists
- Where the ambient temperature is 35°C or more
- Where temperature changes severely
- Where humidity is high
- Where subject to direct sunlight
- Where vibration is severe



Secure minimum spaces as shown below around the unit.

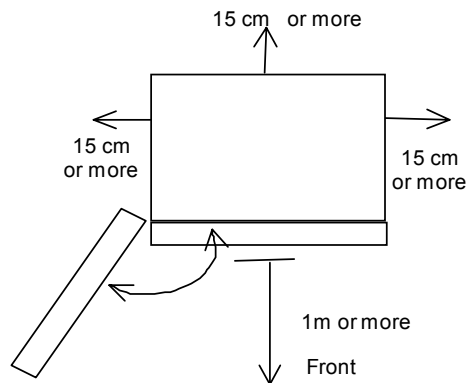

2. Install the unit on a level surface.



Install the unit on a level surface. If the whole bottom surface of the unit does not contact the surface evenly, vibrations or noises may result. This might cause unexpected troubles or malfunctions.

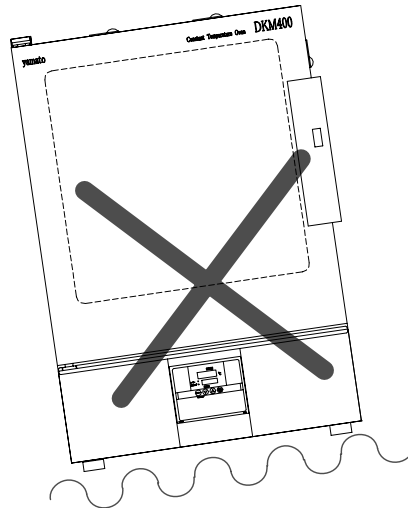

Weight of the unit are: Model DKM300: approx 35 kg; Model DKM400: approx 50 kg, Model DKM600: approx 65 kg.
When lifting the unit for transportation and installation, carefully handle it by at least two people.

3. Installation



The unit might fall down or move by an earthquake or an impact resulting a personal injury. We recommend to make safety measures such as to avoid installing the unit at a place other than busy places.

2. Before operating the unit

Precautions when installing the unit

4. Assure sufficient ventilation for the unit.

- Do not operate the unit when its vent holes on the side and rear panels covered or blocked. Internal temperature of the unit will rise degrading the performance and an accident, a malfunction or a fire may result.

5. Do not operate the unit at such a place that may subject to splash.

- Do not operate the unit at such a place that may subject to splash. Liquid entering the inside may cause an accident, a malfunction, an electrical shock or a fire.

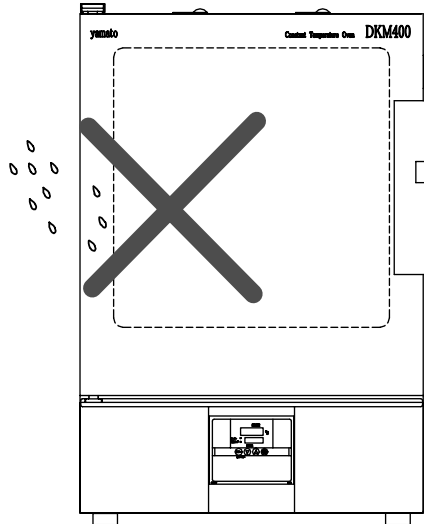

6. Never operate the unit in an atmosphere containing flammable or explosive gas.

- Never operate the unit in an atmosphere containing flammable or explosive gas. Since the unit is not explosion-proof, an arc is discharged when switching the ground fault interrupter "ON" and "OFF" and during operation and a fire or an explosion may result. See the section "13. List of dangerous materials" on page 3 for flammable and explosive gases.

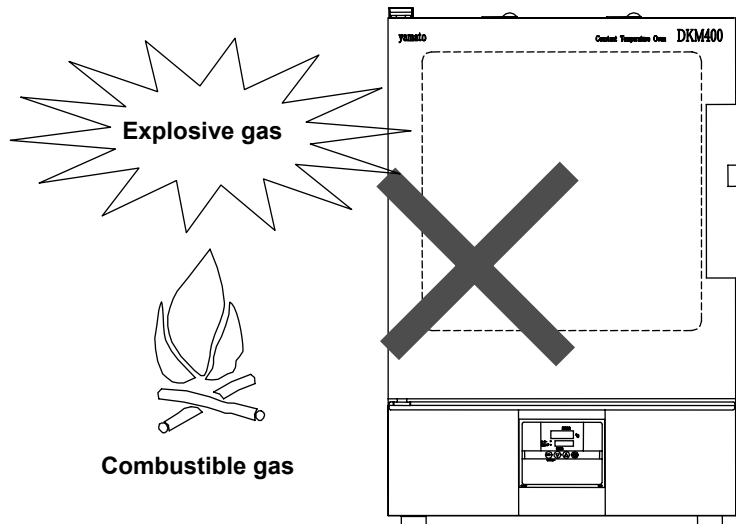

2. Before operating the unit

Precautions when installing the unit

7. Be sure to connect the power plug to the dedicated power distribution panel or a wall outlet.

! Use a power distribution panel or a wall outlet that meets the electrical capacity of the unit.

Electrical capacity:	DKM300	AC100V	8.5A
	DKM400	AC100V	12.5A
	DKM600	AC100V	14A

- * When the unit will not start even when you turn the ground fault interrupter to "ON", check for low main voltage or if the unit is connected to the same power supply line as other devices and connect it to another line if necessary.

Avoid connecting too many devices using a branching outlet or extending a wire with a cord reel or temperature controlling function may degrade due to voltage drop.

! Do not connect the unit to any parts or lines other than a correct power supply line such as a gas pipe, a water pipe or a telephone line. Otherwise, an accident or a malfunction may result.

8. Handling of a power cord

⊘ Never use electrical power cords bundled. When these are used bundled, they might overheat causing a fire.

Never alter, forcibly bend, twist or pull the power cord. Otherwise, a fire or an electrical shock may result.

Do not put the power cord under a desk, a chair or between some objects to avoid damaging it. Otherwise, a fire or an electrical shock may result.

Do not place the power cord close to a stove or other heat generating device.

Sheath of the cord may burn and result in a fire or an electrical shock.

! If the power cord should be damaged (exposure of core wire or disconnection), immediately turn the ELB on the main body, turn the source power off and ask your dealer to replace the cord. Operating the unit with a damaged power cord may cause a fire or an electrical shock.

! Be sure to connect the power cord to a correct wall outlet.

9. Be sure to connect the ground wire.

- ! When the unit has no ground terminal, class D grounding work is necessary and in which case, please consult your dealer or our nearest sales office.
- ! Securely connect to an outlet.

We recommend use of a ground type outlet tap.

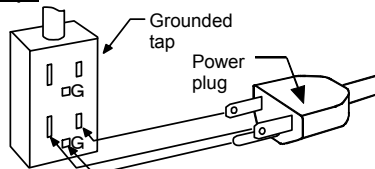

When there is no ground terminal.

In this case, class D grounding work is necessary and please consult your dealer or our nearest sales office.

When a bipolar type outlet tap is used

エラー!

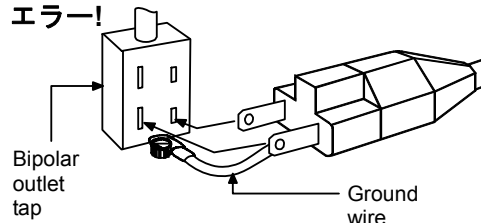

Insert the ground adaptor included as an option, into a power plug confirming the polarity of the outlet. Connect the grounding wire (green) of the ground adaptor to the ground terminal on the power supply equipment.

⊘ Do not connect the grounding wire to any parts or lines other than a correct grounding terminal such as a gas pipe, a water pipe or a telephone line. Otherwise, an accident or a malfunction may result.

2. Before operating the unit

Installation procedures • precautions

- (1) Select an installation site.
 - Make sure that all of four legs are securely on a flat surface.
- (2) Install shelf boards.
 - The lowest shelf board has been secured with screws at the time of shipping from the factory.

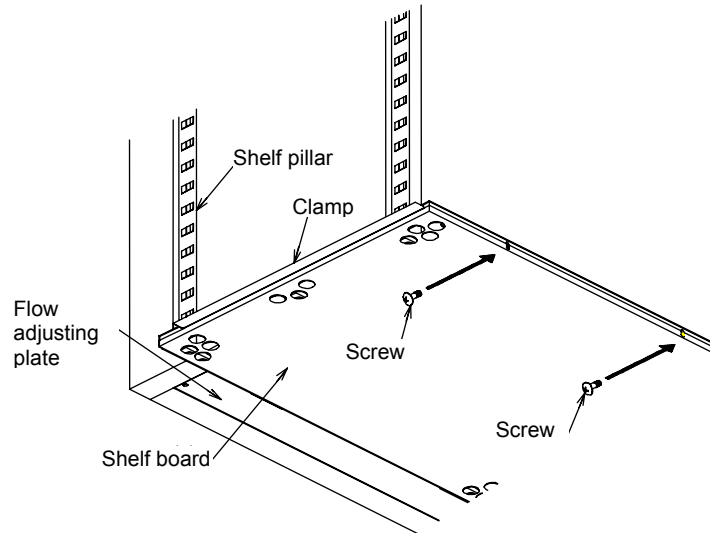

- Install shelf pegs at heights you want on the right and left shelf posts in the internal bath of the main body.
- Completely push shelf boards by sliding to the end.
 - *Take care to put each shelf board on correct pairs of right and left shelf pegs.
- Make sure that shelf boards will not fall nor rattle.
- Withstand load of each shelf board is 15 kg in even loading. When putting samples, arrange them as dispersed as possible.

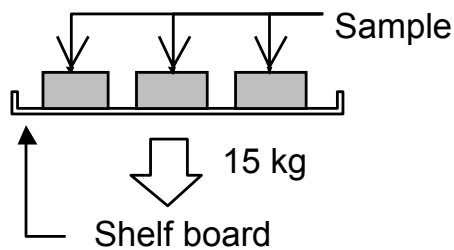

2. Before operating the unit

Installation procedures • precautions

- Put samples with spaces between them. Too many samples may prevent proper temperature control. To assure proper temperature control, put samples with a space at least 30% of the shelf board area.

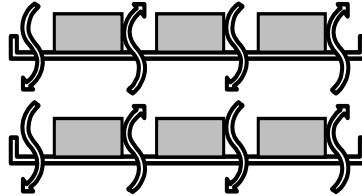

Make at least 30% of space

- (3) Do not put a sample on the bottom of the internal bath.
 - Operating the unit with a sample directly put on the bottom of the internal bath might degrade its temperature characteristics. This also may cause corrosion, damage or rust of the internal bath. Never put any sample on the bottom surface.
 - When putting samples, take care not to allow them touching the wall, where sensor or other devices are installed. Put samples on the shelf board included with the unit.
- (4) Take special care for samples shown below:
 - (1) Samples that contain flammable or explosive components
 - The unit is not explosion proof. Never attempt to dry or process materials that contain flammable or explosive components.
 - (2) Corrosive samples
 - Take care for handling of corrosive samples. Although SUS304 stainless steel is used for major components, note that they might corrode with strong acid. Note that packing may corrode with acid, alkali, oil or organic solvents.
- (5) Always operate the unit with the vent holes open.
 - There are two vent holes on the top surface of the unit. In regular operation, open both of two vent holes. Adjust their opening level according to the water amount contained in a specific sample.



Note that high temperature steam may be blowing out of the vent holes.

To prevent a burn, never try to look into the vent holes or touch those parts with bare hands.

- (6) Always shut the door completely.
 - Make sure that the clamp on the right side of the door is completely locked before operating the unit.

2. Before operating the unit

Installation procedures • precautions

- (7) About two-tier stacking
 - Use the dedicated optional parts to stack units in two tiers. Contact your dealer or the nearest sales office for the dedicated optional part.

- (8) Before using the unit for the first time
 - When you operate the unit for the first time at a higher temperature, the unit may generate an odor. This is due to decomposed bonding material contained in heat-insulation material and is not a malfunction of the unit. We recommend operating the unit at the highest temperature once before starting its regular operation.

3. Names and functions of parts

Main body

Front panel

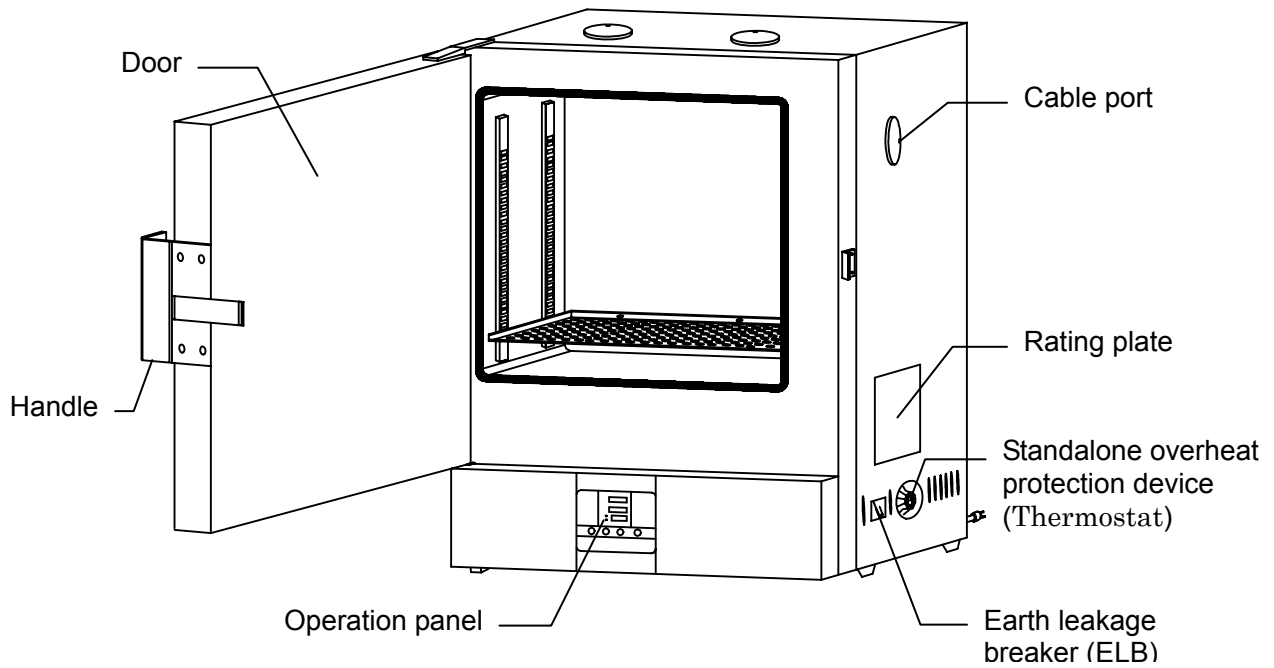

Rear panel

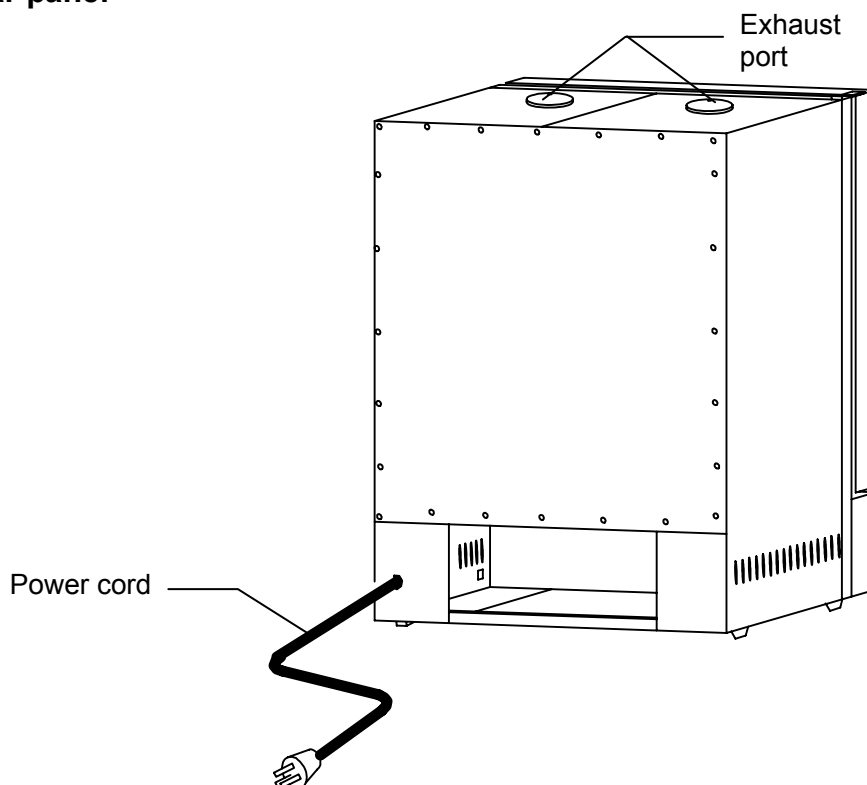

3. Names and functions of parts

Operation panel

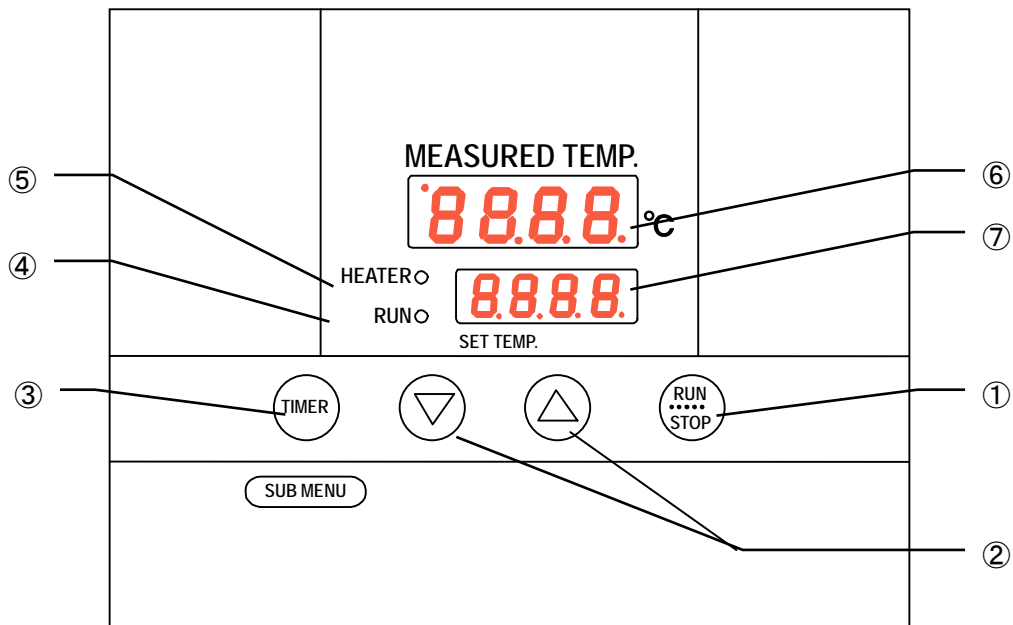





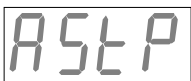

No.	Name	Operation/action
<input type="checkbox"/>	RUN/STOP key	Used for starting/stopping operation.
<input type="checkbox"/>	▼▲ key	Used for selecting settings.
<input type="checkbox"/>	TIMER key	Key for selecting timer operation settings. Quick auto stop operation, auto stop operation or auto start operation can be selected.
<input type="checkbox"/>	SUB MENU key (Long press of the TIMER key)	Key for setting calibration offset temperature, the key lock function or the power outage compensation function.
<input type="checkbox"/>	RUN lamp	Illuminates during fixed temperature operation and blinks during timer operation.
<input type="checkbox"/>	HEATER lamp	Illuminates while heater power is on.
<input type="checkbox"/>	MEASURED TEMP. screen	Displays measured temperature in the bath/set characters/ alarm information.
<input type="checkbox"/>	SET TEMP. screen	Displays a set temperature, timer settings and timer remaining time.

3. Names and functions of parts

Explanation of characters

Characters on the controller are explained in this section.

Characters	Identifier	Name	Application
	AStP	Auto stop setting	Used for setting auto stop operation
	AStr	Auto start setting	Used for setting auto start operation
	End	Time up	Displayed when timer operation has ended. See page 18 and 20.
	cAL	Calibration offset setting	Used for inputting a calibration offset temperature. See section "Using the calibration offset function" on page 24.
	Lock	Key lock of settings	Key locks settings to prevent their alteration. See section "Using the lock function" on page 25.
	Pon	Power outage compensation setting	Used for setting auto start operation. See section "Using the power outage compensation function" on page 26.

* See the section "Operation mode · function setting keys and characters" on page 15 for characters of operation modes and functions.

4. Operating procedures

List of operation modes and functions

Operation modes of the unit are as shown below:

No	Name	Description	Page
1	Fixed temperature operation	Turning the ELB on to enter the operation setting mode. Proceed to temperature setting that uses ▼▲ keys. Pressing the RUN/STOP key longer starts operation, and pressing the RUN/STOP key longer again stops operation.	P.17
2	Quick auto stop operation	Used when you want to “stop fixed temperature operation being performed automatically in several hours. Press the TIMER key during fixed temperature operation to display “AStP.” Set a duration before stop with the ▼▲ keys. Pressing the RUN/STOP key starts quick auto stop operation and activates the timer in the middle of it to automatically stop it after the set period of time.	P.18
3	Auto stop operation	Used when you want to “set automatic stop for fixed temperature operation when making settings for it.” Press the TIMER key to display “AStP.” Set a duration before stop with the ▼▲ keys. Pressing the RUN/STOP key starts auto stop operation.	P.20
4	Auto start operation	Used when you want to “start operation automatically after several hours” after power is turned on. Press the TIMER key to display “AStr.” Set a duration before stop with the ▼▲ keys. Pressing the RUN/STOP key starts auto start operation.	P.22
* Operation mode cannot be changed while the unit is in operation. First stop operation before changing the mode.			

4. Operating procedures

List of operation modes and functions

Functions of the unit are as shown below:

No	Name	Description	Page
1	Overheat prevention function	<p>Automatic overheat prevention function :</p> <p>This function is linked to the unit set temperature and has been set to so that it is automatically activated (returned automatically) at a temperature 12□ higher than the set temperature in the bath.</p> <p>Standalone overheat protection device (Thermostat) :</p> <p>When the temperature in the bath reaches the set temperature of the standalone overheat protection device (Thermostat), its heater circuit trips to shut off controller operation.</p> <p>The temperature can be set with the manual dial on the hydraulic overheat prevention device installed at the right side of the unit.</p>	P.16
2	Calibration offset function	<p>Calibration offset function compensates any differences between the target temperature in the bath and the control temperature of the controller (sensor temperature.)</p> <p>The function can compensate to either plus or minus side for the whole temperature band of the unit.</p> <p>This compensation can be set with the SUB MENU keys.</p>	P.24
3	Setting lock function	<p>This function locks the set operation status.</p> <p>The lock can be set or released with the SUB MENU keys.</p>	P.25
4	Power outage compensation function	<p>This function returns the main unit operation to the resume status after recovery from power outage, or keeps the current stop status.</p> <p>This compensation can be set with the SUB MENU keys.</p>	P.26

4. Operating procedures

Operation mode · function setting keys and characters

Key operations and characters in the diagram below are used for operation mode and function settings.

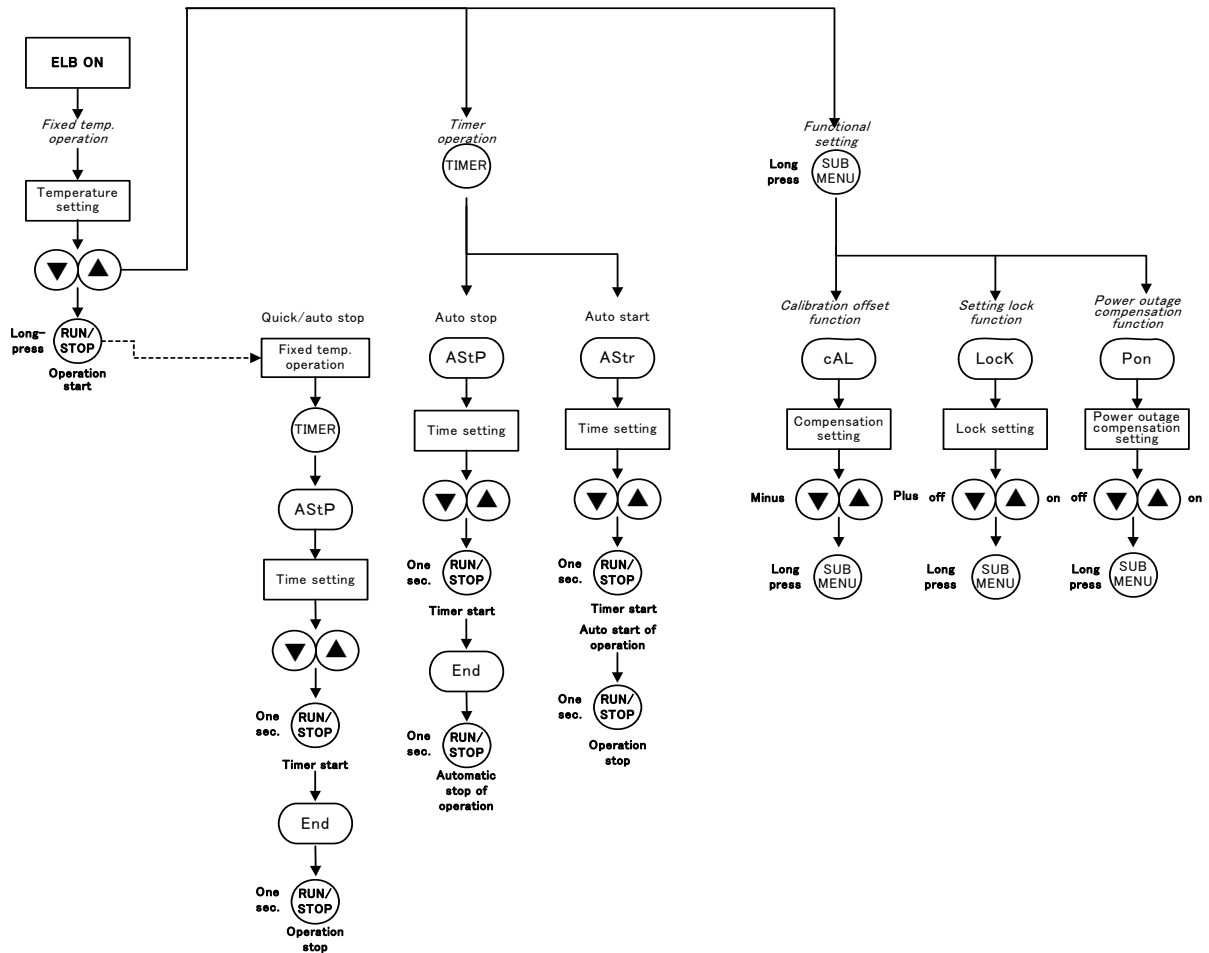

4. Operating procedures

Operating procedures (settings for Standalone overheat prevention device (Thermostat))

As a safety measure for preventing overheat, a standalone overheat prevention device (Thermostat) hydraulic overheat prevention device (manual return) is installed.

Temperature setting range and functions

The temperature setting range for the standalone overheat prevention device (Thermostat) is “50□ ~ 350□.”

When the temperature in the bath keeps rising beyond the controller set temperature and reaches the set temperature of the standalone overheat prevention device (Thermostat), the heater circuit trips and the controller operation is shut off.

When the standalone overheat prevention device (Thermostat) is activated, it will not be released until the ELB is turned on.

How to set temperature

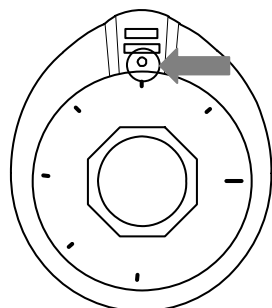

Set the temperature scale to the arrow

Setting the standalone overheat prevention device (Thermostat)

- Set the temperature scale on the standalone overheat prevention device (Thermostat) installed on the right side of the unit to the arrow in the diagram shown left.
- Turn the ELB to “OFF” and wait for a while without opening the door.
- After a while, turn the ELB “ON.” (Turn the ELB “ON”.)

Caution

- ① Set temperature as “set temperature +20□” as a rough standard and add 5□ to the setting if the device functions improperly.
- ②□ The temperature setting range for the standalone overheat prevention device (Thermostat) is “50□ ~ 350□.” Be sure to set the overheat prevention activation temperature correctly otherwise the device may not start, the standalone overheat prevention device (Thermostat) overheat prevention device is activated before temperature in the bath increases completely, or a fire or other unexpected accidents may result.
The temperature is set at 350□ on shipping from the factory.
- ③ If the temperature for the standalone overheat prevention device (Thermostat) is set at around or below the room temperature, the device may be triggered when the door is opened.
- ④ The standalone overheat prevention device (Thermostat) has been designed to prevent overheating of devices not to protect samples. The device does not prevent accidents caused from use of explosive or flammable materials.

4. Operating procedures

Operating procedures (fixed temperature operation)

How to start fixed temperature operation

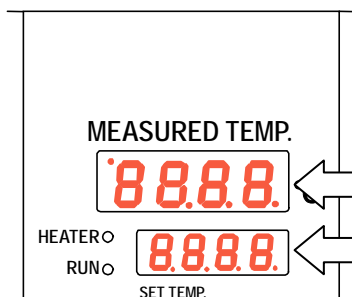

1. Turn the ELB ON. (Turn the ELB to “ON.”)

When the ELB is turned ON, the initial values will be displayed for about four seconds, then the initial screen will appear and the current bath temperature and the previous set temperature are displayed on each of the indicators.

Measured temperature screen: Displays the current bath temperature

Set temperature screen: Displays the previous set temperature

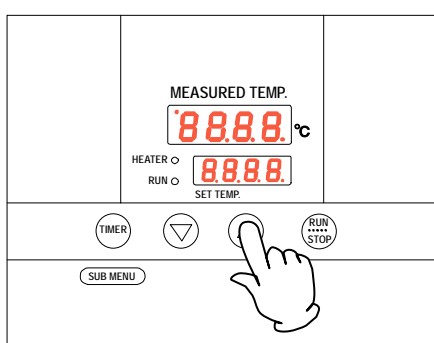

2. Setting the temperature

Set a temperature using the ▼▲ keys.

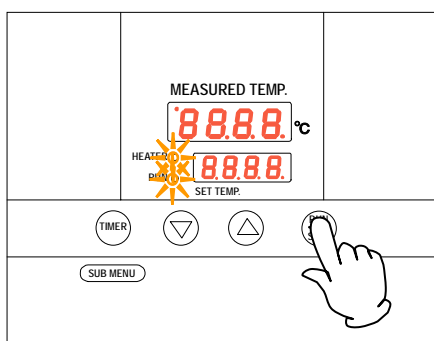

3. Starting operation

Press the **RUN/STOP** key longer.

Fixed temperature operation will start and the RUN lamp and the HEATER lamp come on.

4. Stopping operation

Press the **RUN/STOP** key longer.

Operation stops, the RUN lamp goes off and the screen switches to the initial setting screen.

When you want to correct setting errors or change settings

When you want to change settings, press the ▼▲ keys on the current screen to enter the setting mode where you can change settings. Blink stops three seconds after three seconds after change and setting is completed.



Caution

- ① When you want to lower the set temperature during fixed temperature operation, note that it takes some time to reach the reset temperature since the unit has no cooling capacity.
- ② Immediately after operation has been stopped, the temperature in the bath is around the set temperature. Operation stop refers only to machine stop and time needed for decreasing the temperature in the bath is not considered.

4. Operating procedures

Operating procedures (quick auto stop operation)

Used when you want to “stop fixed temperature operation being performed automatically in several hours. Quick auto stop operation is a function to enable auto stop timer setting during operation.

Procedures for quick auto stop operation

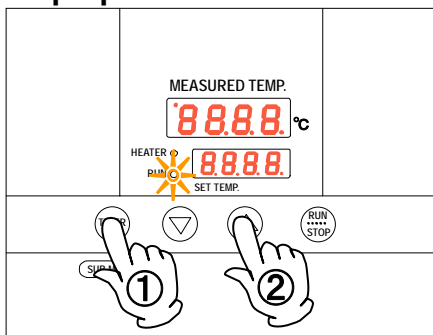

1. Setting time period before stop during fixed temperature operation

- Make sure that the RUN lamp is illuminated to indicate the unit is in operation.

Press the **TIMER** key.

Characters **AStP** **ASTP** are indicated on the MEASURED TEMP. screen to indicate the auto stop operation mode and set duration blinks on the SET TEMP. screen.

- Set a duration you want using the **▼▲** keys.

About the timer function

The maximum time that can be set for the timer is 999 hours 50 minutes.

Up to 99 hours 59 minutes, time can be set in minutes.

One hundred hours and over are set only in 10 minutes.

Keep the **▼▲** keys pressed to continuously change set time and you can quickly reach the time you want. Press the **▼▲** keys once at a time for fine adjustment.

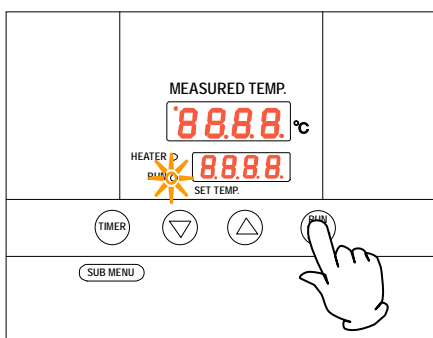

2. Starting timer operation

When the time you want is set, press the RUN/STOP key while the SET TEMP. screen is blinking.

The RUN lamp blinks and timer operation is started.

TIMER starts counting when the temperature in the bath reaches the set temperature.

Once timer counting is started, the SET TEMP. screen changes to the remaining time display.

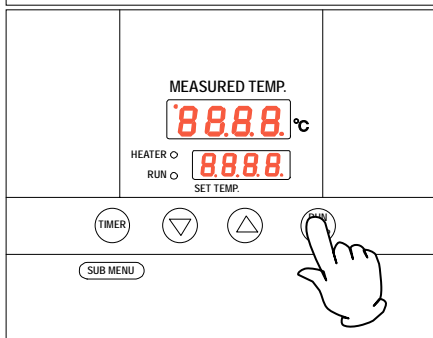

3. Stopping and ending timer operation

Operation stops automatically when the set temperature has elapsed.

Characters **End** **End** blink on the SET TEMP. screen to indicate operation has ended.

Press the **RUN/STOP** key for approx. one second to end the timer operation mode. The screen switches to the initial setting screen.

4. Operating procedures

Operating procedures (quick auto stop operation)

When you want to correct set temperature or set time, or change settings

When you want to change settings, press the ▼▲ keys on the current screen to enter the setting mode where you can change settings. Blink stops three seconds after three seconds after change and setting is completed. Note, however, that temperature changes after timer activation are counted also while temperature is changing.

When you want to change settings before timer activation, press the **TIMER** key on the current screen to enter the setting mode where you can change settings. Enter a time duration from when the set temperature is reached to the time the device shall be stopped.

When you want to change settings after timer activation, press the **TIMER** key on the current screen to enter the setting mode where you can change settings. Note, however, you need to set a time calculated by adding the time already passed to the time to be added.

After change has been made, press the **RUN/STOP** key to complete the process.

When you want to stop quick auto stop operation in the middle of it, press the **RUN/STOP** key long once to stop device control once, then make settings again in the appropriate mode.

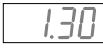
In terms of the remaining time display  a blinking dot indicates count down, an illuminated dot indicates the wait status (temperature is increasing or decreasing to the set temperature) when the timer stops counting.

4. Operating procedures

Operating procedures (auto stop operation)

This mode automatically stops fixed temperature operation after a certain time from its start set with the timer.

Procedures for auto stop operation

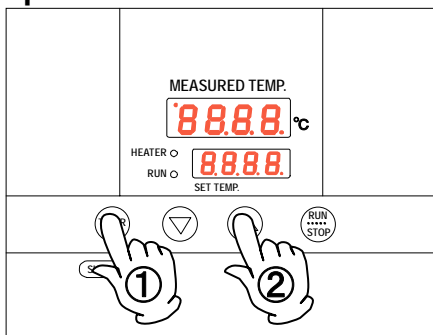

1. Setting a stop time

- ① After confirming the temperature you want is set, press the **TIMER** key to display characters ASTP **ASTP** on the **MEASURED TEMP.** screen that indicate auto stop operation.
The set time is displayed on the **SET TEMP.** screen.
- ② Set a duration you want using the **▼▲** keys.
Pressing the **▼▲** keys makes the set time blink. The time is determined when blinking stops.

About the timer function

The maximum time that can be set for the timer is 999 hours 50 minutes.

Up to 99 hours 59 minutes, time can be set in minutes.

One hundred hours and over are set only in 10 minutes.

Keep the **▼▲** keys pressed to continuously change set time and you can quickly reach the time you want. Press the **▼▲** keys once at a time for fine adjustment.

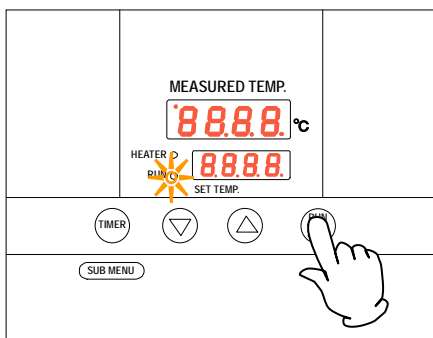

2. Starting timer operation

When the time you want is set, press the **RUN/STOP** key long while characters ASTP **ASTP** that indicate auto stop operation are displayed on the **MEASURED TEMP.** screen and the set time on the **SET TEMP.** screen.

The **RUN** lamp blinks and timer operation is started.

TIMER starts counting when the temperature in the bath reaches the set temperature.

Once timer counting is started, the **SET TEMP.** screen changes to the remaining time display.

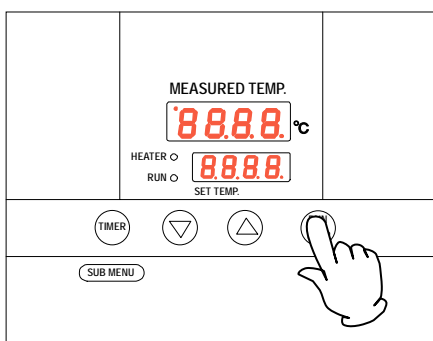

3. Stopping and ending timer operation

Operation stops automatically when the set temperature has elapsed.

Characters **End** **End** blink on the **SET TEMP.** screen to indicate operation has ended.

Press the **RUN/STOP** key for approx. one second to end the timer operation mode. The screen switches to the initial setting screen.

4. Operating procedures

Operating procedures (auto stop operation)

When you want to correct set temperature or set time, or change settings

When you want to change settings, press the ▼▲ keys on the current screen to enter the setting mode where you can change settings. Blink stops three seconds after three seconds after change and setting is completed. Note, however, that temperature changes after timer activation are counted also while temperature is changing.

When you want to change settings before timer activation, press the **TIMER** key on the current screen to enter the setting mode where you can change settings. Enter a time duration from when the set temperature is reached to the time the device shall be stopped.

When you want to change settings after timer activation, press the **TIMER** key on the current screen to enter the setting mode where you can change settings. Note, however, you need to set a time calculated by adding the time already passed to the time to be added.

After change has been made, press the **RUN/STOP** key to complete the process.

Auto stop operation is not available together with auto start operation.

When you want to stop auto stop operation in the middle of it, press the **RUN/STOP** key long once to stop device control once, then make settings again in the appropriate mode.

In terms of the remaining time display  a blinking dot indicates count down and an illuminating dot indicates a wait status (while temperature is increasing or decreasing to the set temperature) during which the timer has stopped counting.

4. Operating procedures

Operating procedures (auto start operation)

This mode automatically starts fixed temperature operation after a certain time from its start set with the timer.

However, operation does not stop automatically but needs to be stopped manually.

Procedures for auto start operation

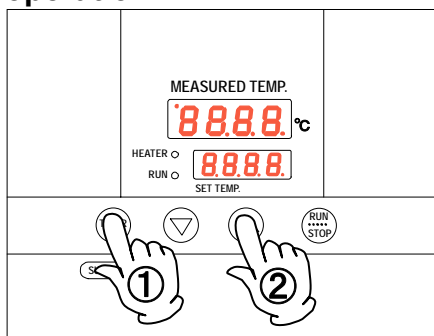

1. Setting an operation start time

- After confirming the temperature you want is set, press the **TIMER** key to display characters AStr **AStr** on the MEASURED TEMP. screen that indicate auto start operation.
The set time is displayed blinking on the set temperature screen.
- Set a duration you want using the **▼▲** keys.
Pressing the **▼▲** keys makes the set time blink. The time is determined when blinking stops.

About the timer function

The maximum time that can be set for the timer is 999 hours 50 minutes.

Up to 99 hours 59 minutes, time can be set in minutes.

One hundred hours and over are set only in 10 minutes.

Keep the **▼▲** keys pressed to continuously change set time and you can quickly reach the time you want. Press the **▼▲** keys once at a time for fine adjustment.

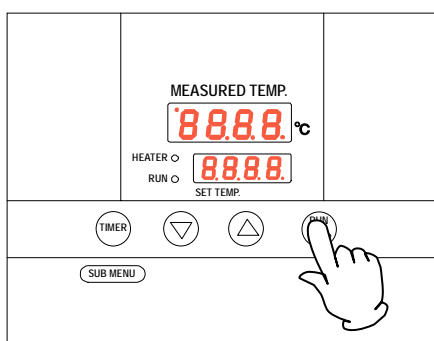

2. Starting timer operation

When the time you want is set, press the **RUN/STOP** key while characters AStr **AStr** that indicate auto start operation are displayed on the MEASURED TEMP. screen and the set time on the SET TEMP. screen.

Timer starts counting when the **RUN/STOP** key is pressed.

Display on the SET TEMP. screen switches from set time display to remaining time display.

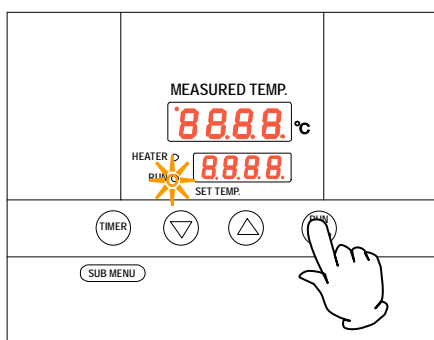

3. Stopping and ending timer operation

Operation automatically starts at the set time and the RUN lamp comes on.

To stop operation, press the **RUN/STOP** key for approx. one second to end the timer operation mode. The screen switches to the initial setting screen.

4. Operating procedures

Operating procedures (auto start operation)

When you want to correct set temperature or set time, or change settings

When you want to change the set temperature during timer counting, press the ▼▲ keys during that status to switch the SET TEMP. screen to the set temperature input mode, which blinks to enable change of the set temperature with the ▼▲ keys.

When you want to change the set time during timer counting, press the **TIMER** key during that status to switch the SET TEMP. screen to the set time input mode, which blinks to enable change of the set time with the ▼▲ keys.

In either case, the SET TEMP. screen will stop blinking after a while and switches to the timer count mode and the change made is determined. Note, however, when you change the set time you need to set a time calculated by adding the time already passed to the time to be added.

When operation has started after the auto start time, you cannot change the set time.

When you want to stop auto start operation in the middle of it, press the **RUN/STOP** key long to stop device control once, then make settings again in the appropriate mode.

In terms of the remaining time display  a blinking dot indicates count down and an illuminating dot indicates a wait status (while temperature is increasing or decreasing to the set temperature) during which the timer has stopped counting.

4. Operating procedures

Useful functions (calibration offset function)

Using the calibration offset function

Calibration offset function compensates any differences between the target temperature in the bath and the control temperature of the controller (sensor temperature.) The function can compensate in parallel to either plus or minus side for the whole temperature band of the unit.

The lock can be set or released with the **[SUB MENU]** keys.

The temperature is set at "0" on shipping from the factory.

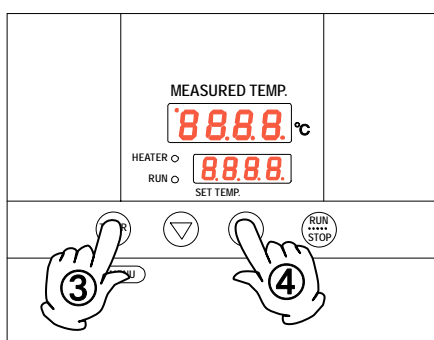
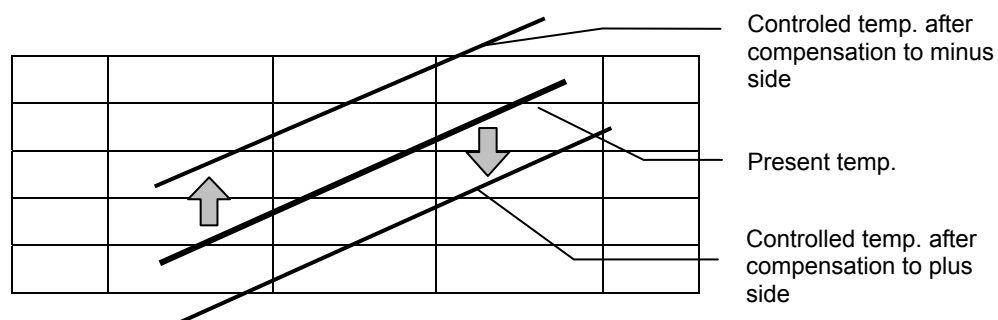

- Start operation at the target set temperature and confirm the temperature in the bath with a temperature recorder after temperature has stabilized.
- Confirm the difference between the set temperature and that in the bath.
- Press the **[TIMER]** key (**[SUB MENU]** key) long to enter the sub menu mode. Press the **[TIMER]** key (**[SUB MENU]** key) several times to select the characters **cAL cAL** that indicate the calibration offset function.
- Enter the difference between the set temperature and the temperature in the bath using the **▼▲** keys and press the **[TIMER]** key (**[SUB MENU]** key) long to exit the sub menu mode. (When you want to set the key lock function, proceed to character selection process for the key lock function without pressing the **[TIMER]** key (**[SUB MENU]** key) long.)

- * You can set either of + or – side for the offset compensation temperature. When compensation is set for the – side, the MEASURED TEMP. display decreases by the compensation temperature while the temperature in the bath increases by the same amount. When compensation is set for the + side, the MEASURED TEMP. display increases by the compensation temperature while the temperature in the bath decreases by the same amount.
- * Since too large a compensation value may result in larger difference between the actual and indicated temperatures and may present a danger, consult our nearest sales office before entering a large compensation value.
- * The device has, in addition to the calibration offset function, the two-point compensation function that adjusts offset for the lower temperature range and higher temperature range, for which adjustment temperatures have been input on shipping from the factory.
- * Consult the nearest sales office before attempting validation work for the temperature adjusting device.

4. Operating procedures

Useful function (setting lock function)

Using the lock function

This function locks the set operation status.

The temperature is set at “off” on shipping from the factory.

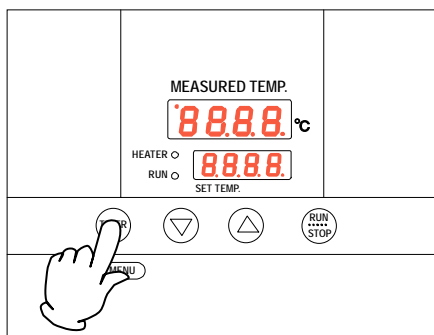

- Press the **TIMER** key (**SUB MENU** key) long to enter the sub menu mode. Press the **TIMER** key (**SUB MENU** key) several times to select the characters Lock **Loch** that indicate the setting lock function.

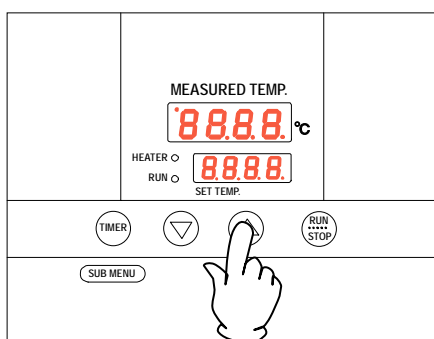

- ② “Off” is displayed on the SET TEMP. screen. To lock settings, change to “on” using the **▲** key. Press the **TIMER** key (**SUB MENU** key) long to exit the sub menu mode.

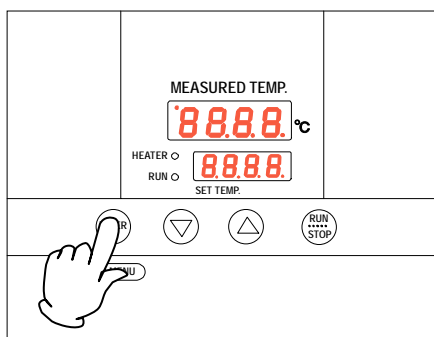

- To release lock, press the **TIMER** key (**SUB MENU** key) long again and select the characters Lock **Loch** that indicate setting lock using the **▼▲** keys. Lock is released when “off” is selected using the **▼** key.
- * When the lock function is “on”, keys other than the **RUN/STOP** key and the **TIMER** key (**SUB MENU** key) are locked.

4. Operating procedures

Useful function (power outage compensation function)

Using the power outage compensation function

The power outage compensation function returns the main unit operation to the resume status after recovery from power outage, or keeps the current stop status.

The function is set at “on” on shipping from the factory.

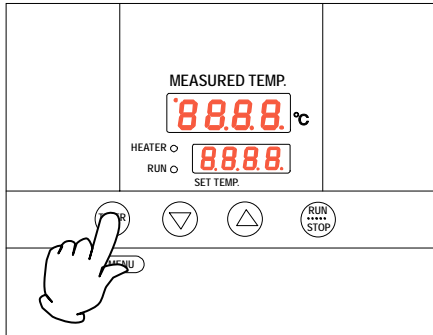

- Press the **TIMER** key (**SUB MENU** key) long to enter the sub menu mode.

Press the **TIMER** key (**SUB MENU** key) several times to select the characters Pon **Pon** that indicate the power outage compensation function.

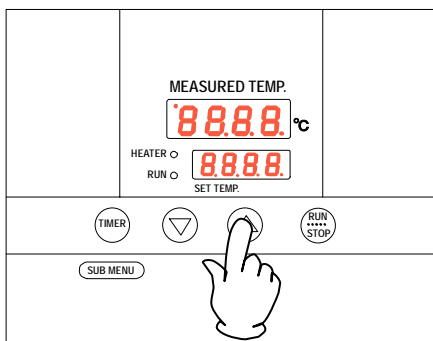

- “On” is displayed on the SET TEMP. screen. The device keeps stop status after recovery from power outage when this setting is set to “off” using the ▼ key. Press the **TIMER** key (**SUB MENU** key) long to exit the sub menu mode.

5. Cautions on handling



Warning

1. About handling of flammable or combustible solution

-  The unit is not explosion proof. Take special care for handling samples on which explosive materials, combustible materials or materials containing these are attached. Flammable or combustible solution will evaporate when left at a room temperature (or at a lower temperature for some types of solutions) and may be ignited and explode from switches, lights and other ignitable sources. Be sure to assure sufficient ventilation when using these materials.

See section "13. List of dangerous materials" on page 38.

2. Ban on use/countermeasures when an error occurs

-  If smoke is emerges on the unit or an odd odor is felt, immediately turn the ELB on the main unit off, turn the power supply off and contact your dealer or a Yamato sales office for inspection. Otherwise, a fire or an electrical shock may result. The user shall never attempt to repair the unit to avoid any possible dangers.

3. Secure sufficient ventilation for the unit.

-  Do not operate the unit when its vent holes on the side and rear panels covered or blocked. Internal temperature of the unit will rise degrading the performance and an accident, a malfunction or a fire may result.

4. Do not allow liquid to spill over the unit.

-  Do not allow liquid to spill over the unit. Pay special attention not to allow liquid to enter into the vent holes on the side and rear panels of the unit. If liquid is spilt over or into the unit, do not try to operate it any further. Other wise, an accident, a malfunction, a fire or an electrical shock may result.

5. Do not allow a metal piece to fall into the unit.

-  Do not allow a clip, a staple, a screw or other metal pieces to fall into the unit. Stop operating the unit if a metal piece has dropped into the unit. Other wise, an accident, a malfunction, a fire or an electrical shock may result.

6. Do not open the cabinet.

-  Do not open panels or covers fixed on the unit, or do not operate the unit with any of those open. Other wise, an accident, a malfunction, or an electrical shock may result.

7. Always operate the unit at a correct ambient temperature.

-  The operating temperature range is room temperature range from 10~260□ above room temperature.
Never try to operate the unit outside the operating temperature range.

8. Do not attempt to modify the unit.

-  The user shall never try to modify the unit; other wise, an accident, a malfunction, a fire or an electrical shock may result.

5. Cautions on handling



Caution

1. Do not step on the unit.



Do not step on the unit. Otherwise, the unit may trip over or be damaged resulting a personal injury or a malfunction.

2. Do not put or drop an object on the unit.



2.Do not put or drop an object on the unit. Since the unit contains high precision devices, vibrations or shock may cause a malfunction.

3. When a thunder is heard.



When a thunder is heard, turn the ELB on the main unit off then turn the main power off immediately. Otherwise, a lightning strike may result and cause a fire.

4. During night and not to be operated for a long period of time.



During the night and when you want to stop the unit for a longer period of time, turn the ELB to "off" and pull out the power cord from the power supply.

5. About recovery from power outage.



When the power is applied again after the unit has stopped due to power outage, the unit will automatically return to the status immediately before the power outage and resumes operation.

Turn the ELB off if you do not want to resume operation by automatic recovery.

6. About two-tier stacking



Use the dedicated optional parts to stack units in two tiers. Contact you dealer or the nearest sales office for the dedicated optional part.

7. When opening or closing the door



When opening or closing the door, do not put your hand or face close to the area the door moves (space).

The door may touch your hand or face and causing an injury.

8. Do not operate the unit with the door open.



- When the unit is operated with the door open, proper temperature control is not possible and the heater may overheat pausing a possible danger. Be sure to operate the unit with the door closed.
- After operation has been completed, do not leave the unit with its door open in order to, for example, cool down samples earlier. Heat from inside the bath may cause deformation of the control panel of a malfunction of the control devices.

5. Cautions on handling



9. About installation of shelf boards and samples



Install shelf boards and samples correctly according to "Installation procedures • precautions" on page 7. Otherwise, an accident or a malfunction may result not only to prevent the unit to operate at its maximum performance.

10. Do not attempt to do anything other than specified in this operation manual.



Do not attempt to do anything other than specified in this operation manual. Otherwise, an unexpected accident may result.

6. Maintenance procedures

Daily inspection/maintenance

Be sure to perform daily inspection and maintenance to assure reliable operation of the unit.

Warning

- Be sure to pull out the power cord unless necessary before trying to do inspection and maintenance works.
- Start these works after the device has returned to the normal temperature.
- Never try to disassemble the unit.

Caution

- Wipe off any dirt with a tightly wrung soft cloth. Never try to clean the unit with benzene, thinner or scouring powder, or rub with a scrubbing brush. Deformation, degradation or discoloration may result.

Every month

Inspect the functions of the Earth Leakage Breaker.

Test shall be performed with the power cord connected and power is being supplied to the unit.

- First turn the ELB to “off.”
- Then, turn the ELB “on” and press the test button on the device with a ball-point pen to check whether it is turned off to indicate that it is in the normal state.

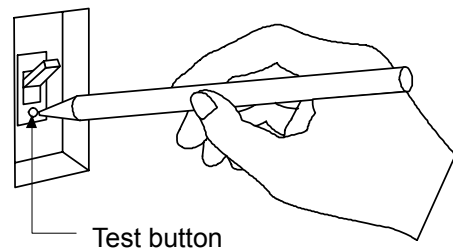

Maintenance of the internal bath

Stop operation and turn the ELB to OFF. Pull out the power cord off the distribution board and the wall outlet. Confirm the temperature in the device and remove shelf boards and clamps.

The internal bath, shelf boards and shelf clamps are made of SUS304 stainless steel. To clean these items, thoroughly wipe with a cloth moistened with cleaning alcohol then wipe gently with a dry cloth.

Never use acid detergent, alkaline detergent, oil or organic solvent, which may cause corrosion or damage to the products.



There are sharp protrusions inside the internal bath, shelf boards and shelf pillars and shall be handled with special care to avoid personal injury. Be sure to wear gloves since handling with bare hands may present danger.

7. When the unit is not to be used for a long time or when disposing

When the unit is not to be used for a long time or when disposing

Caution

When the unit is not going to be used for a long time

- Turn the ELB to off and pull out the power cord.

Warning

When disposing the unit

- Do not leave the unit in the area where children may have access.
- Be sure to remove handles before disposing the unit to prevent the doors from locking.
- In general, dispose the unit as a bulky waste.

Notes about disposition

Always pay attention to the preservation of the global environment.

- We highly recommend taking the unit apart as far as possible for separation or recycling to contribute to the preservation of the global environment. Major components and materials for the unit are as follows:

Names of major components	Major materials
Major exterior components	
Exterior	Bonderized steel sheet iron, melamine resin baking finish
Internal bath	Stainless steel SUS304
Heat insulator	Glass wool
Packing	Silicon rubber
Nameplates	Polyethylene (PET) resin film
Major electric parts	
Switches and relays	Resin, copper
Boards	Glass fiber and other composite parts
Heater	SUS304
Power cord	Synthesized rubber sheath, copper, nickel

8. Troubleshooting



Safety device and error codes

The unit has the self diagnostic function with a controller and a separate safety device.

Table below shows possible causes and measures when the safety device is triggered.

[Error codes]

When a functional or mechanical abnormality occurs, an error code will be displayed on the control panel. When an abnormality occurs, confirm the error code and immediately stop operation.

Safety device	Symptom	Possible causes and measures
Sensor error	 appears	<ul style="list-style-type: none">• Error in the temperature input circuit• Disconnection or other errors in the temperature sensor• Measured temperature is outside the displayable range. Contact our service department.
Memory error	 appears	<ul style="list-style-type: none">• Memory setting error Contact our service department.
Measured temperature error	----- ----- appears	<ul style="list-style-type: none">• When the upper limit alarm of the temperature alarm function is triggered. Contact our service department.

8. Troubleshooting

When a malfunction is suspected

If any of the symptoms below occurs

Symptom	Check
Turning the ELB to on will not activate the unit.	<ul style="list-style-type: none">● Check if the power cord is connected to the power supply securely.● Check if power outage is occurring.● Check if the standalone overheat prevention device is working.
Temperature does not rise.	<ul style="list-style-type: none">● Check if the set temperature is below that in the device.● Check if the power supply voltage has declined.● Check if the ambient temperature is low.● Check if cooling load for inside the bath is too large.
Temperature fluctuates during operation.	<ul style="list-style-type: none">● Check if the set temperature is appropriate.● Check if the power supply voltage has declined.● Check if ambient temperature fluctuates widely.● Check if cooling load for inside the bath is too large.
Displayed temperature differs from the measurement.	<ul style="list-style-type: none">● Check if the calibration offset setting is other than "0". Set it to "0." Confirm the settings in "Using the calibration offset function" on page 24.

If power outage occurs

When the power is applied again after the unit has stopped due to power outage, the unit will automatically return to the status immediately before the power outage and resumes operation. Turn the ELB off if you do not want to resume operation by automatic recovery.

- If the symptom does not match any of the above, immediately turn the ELB on the main unit off, pull out the power cord from the power supply and contact your dealer or one of our sales offices.

9. After sales service and warranty

When requesting a repair

When requesting a repair

If any trouble occurs, immediately stop operation, turn the ELB off, pull out the power plug and contact your dealer or our sales office.

Information necessary for requesting a repair

- Model name of the product
 - Serial number
 - Date (y/m/d) of purchase
 - Description of trouble (as in detail as possible)
- } Refer to the warranty card or the nameplate on the unit.
See “3. Names and functions of parts” on page 10.

Be sure to indicate the warranty card to our service representative.

Warranty card (attached separately)

- Warranty card is given by your dealer or one of our sales offices and please fill in your dealer, date of purchase and other information and store securely.
- Warranty period is one full year from the date of purchase. Repair service for free is available according to the conditions written on the warranty card.
- For repairs after the warranty period consult your dealer or one of our sales offices. Paid repair service is available on your request when the product's functionality can be maintained by repair.

Minimum holding period of repair parts

The minimum holding period of repair parts for this product is seven years after end of production.

Repair parts here refer to parts necessary for maintaining performance of the product.

10. Specifications

Model		DKM300	DKM400	DKM600
Performance	Operating temperature range	Room temperature +10℃~260℃		
	Temperature control precision	±1℃ (setting: 210℃)		
	Temperature distribution precision	±2.5℃ (setting: 210℃)		
	Temperature rise time	Approx. 60 minutes (room temperature +10℃~210℃) ; Approx. 90 minutes (room temperature +10℃~260℃)		
Configuration	Cable port	ID 30 mm x 1 (right side)		
	Exhaust port	ID 30 mm x 2 (top side)		
	Fan motor	Sirocco fan x 1		
		0.8 kW	1.2 kW	1.34 kW
	Heater	SUS pipe heater		
0.8 kW		1.2 kW	1.34 kW	
Control assembly	Control system	PID control with a micro computer		
	Setting system	Digital display using up/down keys		
	Operation mode	Fixed temperature operation, quick auto stop operation, auto stop operation, auto start operation.		
	Sensor	K thermocouple		
	Auxiliary functions	Calibration offset function, lock function, power outage compensation function		
Safety device	Self diagnostic function	Temperature sensor error, memory error, auto overheat prevention, measured temperature error		
	Protection device	ELB with an over current protector, Standalone overheat prevention device (Thermostat)		
Standard	Outer dimensions (w x d x h mm)	410×451×670	560×601×820	710×651×870
	Internal dimensions (w x d x h mm)	300×300×300	450×450×450	600×500×500
	Internal volume	27ℓ	90ℓ	150ℓ
	Weight	Approx. 35 kg	Approx. 50 kg	Approx. 65 kg
	Power supply (50/60Hz)	AC100V 8.5A	AC100V 12.5A	AC100V 14A
Included items		Shelf board x 2 (withstand load approx. 15 kg/each), Shelf bracket x 4, operating instructions, warranty card		

*Performance values are for the AC100V power supply with no-load.

*Operating environmental temperature range for this device is 5℃~35℃.

11. Wiring diagram

DKM300/400/600

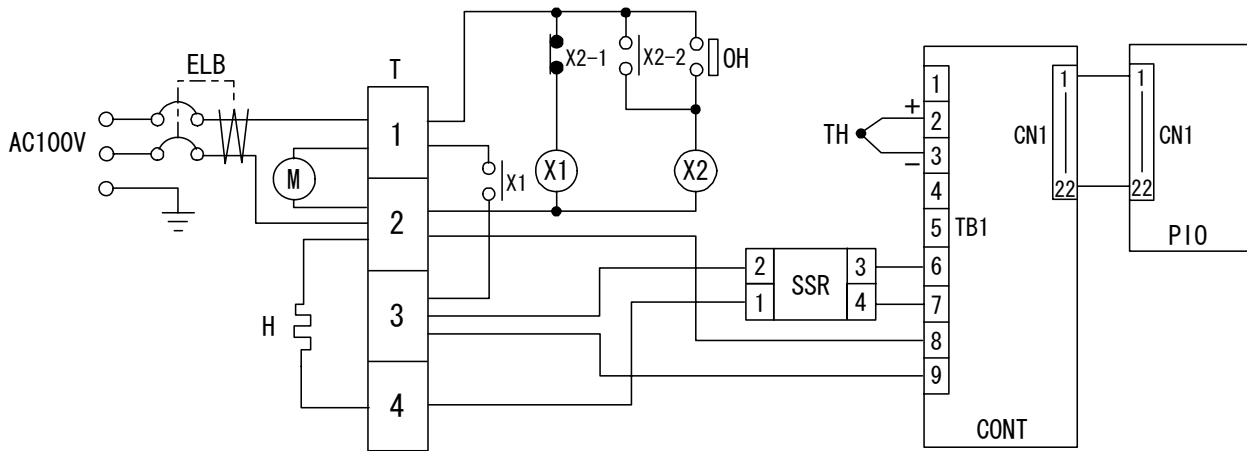

Symbol	Part name	Symbol	Part name
ELB	ELB with an over current protector	SSR	Solid state relay
T	Terminal block	OH	Standalone overheat prevention device (Thermostat)
H	Heater	TH	Temperature sensor (K)
X1, X2	Relay	CONT	Planar board
M	Fan motor	PIO	Display circuit board

12. List of replacement parts

Replacement parts common to DKM300/400/600

Symbol	Part name	Standard	Maker	Code No.
TH1	Sensor	LCK-M1-2000Y K single	Yamato	1160030049
OH	Standalone overheat prevention device (Thermostat)	55.13265.900	E.G.O.	LT00033261
CONT	CN40B-Y planar circuit board	CN40B-Y	Yamato	LT00007640
PIO	CN40B-Y display circuit board	CN40B-Y	Yamato	LT00007639
	Tough card	15P, 300 mm	Yamato	1130000008
X1	Main relay	FC-0T 1b 100V	Fuji	LT00032865
X2	Relay	AP3124K	Matsushita	2050080002
SSR	SSR	TRS5225	Toho	2160000035
	Power cord kit	2.0sq3p with a plug	Yamato	LT00008924
FM	Motor	IC8422YAMA 100V 10W	Yamato	2140000031

Replacement parts for DKM300

Symbol	Part name	Standard	Maker	Code No.
ELB	ELB with an over current protector	NV-L22VC 15A/30mA	Mitsubishi	LT00029774
H	Heater	SUS pipe heater 800W	Yamato	LT00006024

Replacement parts for DKM400

Symbol	Part name	Standard	Maker	Code No.
ELB	ELB with an over current protector	NV-L22VC 15A/30mA	Mitsubishi	LT00029774
H	Heater	SUS pipe heater 1.2 kW	Yamato	LT00006025

Replacement parts for DKM600

Symbol	Part name	Standard	Maker	Code No.
ELB	ELB with an over current protector	NV-L22VC 20A/30mA	Mitsubishi	LT00029776
H	Heater	SUS pipe heater 1.34 kW	Yamato	LT00006026

13. List of dangerous materials



Never use an explosive material, a flammable material or a material containing them for this device.

Explosive substances	Explosive substances	<input type="checkbox"/> Nitro glycol, glycerin trinitrate, cellulose nitrate and other explosive nitrate esters
		<input type="checkbox"/> Trinitrobenzen, trinitrotoluene, picric acid and other explosive nitro compounds
		<input type="checkbox"/> Acetyl hydroperoxide, methyl ethyl ketone peroxide, benzoyl peroxide and other organic peroxides
Flammable substances	Explosive substances	Metal "lithium", metal "potassium", metal "natrium", yellow phosphorus, phosphorus sulfide, red phosphorus, celluloid, calcium carbide (a.k.a, carbide), lime phosphide, magnesium powder, aluminum powder, metal powder other than magnesium and aluminum powder, sodium dithionous acid (a.k.a., hydrosulphite)
	Oxidizing substances	<input type="checkbox"/> Potassium chlorate, sodium chlorate, ammonium chlorate, and other chlorates
		<input type="checkbox"/> Potassium perchlorate, sodium perchlorate, ammonium perchlorate, and other perchlorates
		<input type="checkbox"/> Potassium perchlorate, sodium perchlorate, ammonium perchlorate, and other inorganic perchlorates
		<input type="checkbox"/> Potassium nitrate, sodium nitrate, ammonium nitrate, and other nitrates
		<input type="checkbox"/> Sodium chlorite and other chlorites
	<input type="checkbox"/> Calcium hypochlorite and other hypochlorites	
	Flammable substances	<input type="checkbox"/> Ethyl ether, gasoline, acetaldehyde, propylene chloride, carbon disulfide, and other substances with ignition point at a degree 30 or more degrees below zero.
		<input type="checkbox"/> n-hexane, ethylene oxide, acetone, benzene, methyl ethyl ketone and other substances with ignition point between 30 degrees below zero and less than zero.
		<input type="checkbox"/> Methanol, ethanol, xylene, pentyl acetate, (a.k.a. amyl acetate) and other substances with ignition point between zero and less than 30 degrees.
<input type="checkbox"/> Kerosene, light oil, terebinth oil, isopentyl alcohol (a.k.a. isoamyl alcohol), acetic acid and other substances with ignition point between 30 degrees and less than 65 degrees.		
Combustible gas		Hydrogen, acetylene, ethylene, methane, ethane, propane, butane and other gases combustible at 15 degrees at one air pressure.

(Quoted from the separate table 1 in Article 6, the enforcement order of the Industrial Safety and Health Law)

14. Standard installation manual

*Install the product according to the following: (Confirm separately for optional items or special specifications)

Model	Serial number	Date	Installation mgr. (company name)	Installation mgr.	Judgment

No	Item	Implementation method	TOC No. Reference page of the operating instruction manual	Judgment
Specifications				
1	Included items	Check for number of staffs against the included item field	10.Specifications field P.35	
2	Installation	<ul style="list-style-type: none"> ▪ Visual check of environmental conditions Caution: Take care for environment 	2. Before operating the unit <ul style="list-style-type: none"> ▪ On the installation site P.4	
		<ul style="list-style-type: none"> ▪ Securing a space 		
Operation-related matters				
1	Source voltage	<ul style="list-style-type: none"> ▪ Measure the user side voltage (outlet) with a tester ▪ Measure voltage during operation (shall meet the specifications) Caution: Always use a plug that meets the specification for attaching to the ELB. 	2. Before operating the unit <ul style="list-style-type: none"> ▪ Be sure to connect the ground wire. P.6 ▪ Power supply is P.6 10.Specifications <ul style="list-style-type: none"> ▪ Specification-power supply P.35 	
2	Operation start	<ul style="list-style-type: none"> ▪ Starts operation Performs fixed temperature operation, auto stop operation or auto start operation	2. Before operating the unit... P.8~9 <ul style="list-style-type: none"> ▪ Installation procedures... 4. Operating procedures P.13~26	
Description				
1	Operational descriptions	Explain operations of each component according to the operational instructions	4. Operating procedures P.13~26 <ul style="list-style-type: none"> ▪ Operating procedures 1. Safety precautions P.1~13.List of dangerous materials ~38	
2	Error codes	Explain the customer about error codes and procedures for release according to the operational instructions	8. Troubleshooting ~9. After sales service and warranty P.32~34	
3	Maintenance and inspection	Explain operations of each component according to the operational instructions	6. Maintenance procedures <ul style="list-style-type: none"> ▪ Daily inspection/maintenance P.30	
4	Completion of installation Entries	<ul style="list-style-type: none"> ▪ Fill in the installation date and the installation mgr. on the nameplate of the main unit ▪ Fill in necessary information to the warranty card and hand it over to the customer ▪ Explanation of the route for after-sales service 	9. After sales service and warranty P.34	

Limited liability

Be sure to use the unit strictly following the handling and operating instructions in this operating instruction.

Yamato Scientific Co., Ltd. assumes no responsibility for an accident or a malfunction caused by use of this product in any way not specified in this operating instruction.

Never attempt to perform matters prohibited in this operation instruction.

Otherwise, an unexpected accident may result.

Notice

- **Descriptions in this operating instruction are subject to change without notice.**
- **We will replace a manual with a missing page or paging disorder.**

Operating instruction

Forced Convection Constant Temperature Oven

DKM300/400/600

Third edition December 4 2009

Revision

Yamato Scientific Co., Ltd.

〒103-8432

2-1-6, Nihonbashi, Honcho, Chuo-ku, Tokyo

Customer support center



Toll free: 0120-405525

<http://www.yamato-net.co.jp>